

目 录

一、运输作业组织与管理模块..... 2

二、仓储与配送作业组织与管理模块..... 34

三、国际物流作业组织与管理模块..... 150

四、 快递物流作业组织与管理模块.....	213
-----------------------	-----

湖南商务职业技术学院物流管理专业学生技能考核题库



一、运输作业组织与管理模块



--	--	--

○

○

--	--	--	--	--

() 任务描述

- :
-
-



<input type="checkbox"/> <input type="checkbox"/>				<input type="checkbox"/> <input type="checkbox"/>				
<input type="checkbox"/> <input type="checkbox"/>								
						<input type="checkbox"/> <input type="checkbox"/> <input type="checkbox"/> <input type="checkbox"/>		



() 任务描述:

-
-
-



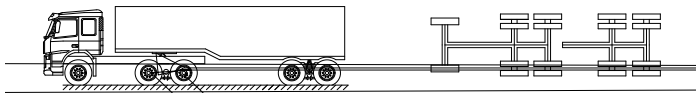
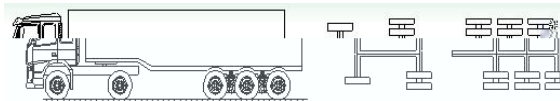

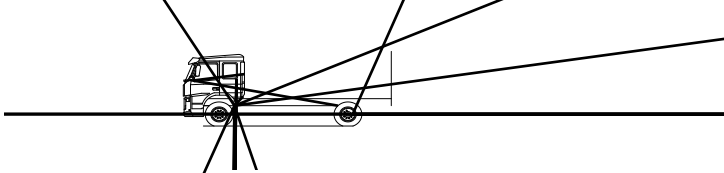
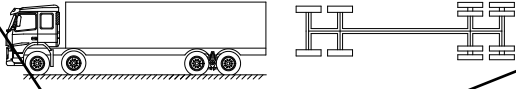
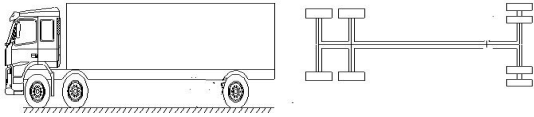

() 任务描述:



○

○

○

○

○

() 任务描述



D

<input type="checkbox"/> <input type="checkbox"/>			<input type="checkbox"/> <input type="checkbox"/>						
<input type="checkbox"/> <input type="checkbox"/>									
						<input type="checkbox"/> <input type="checkbox"/> <input type="checkbox"/> <input type="checkbox"/>			



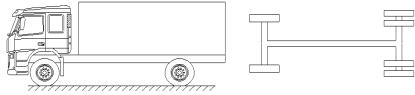
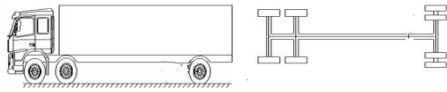
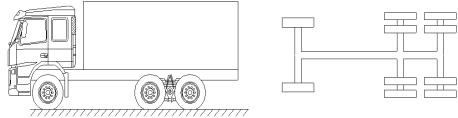

2

3

4

() 任务描述



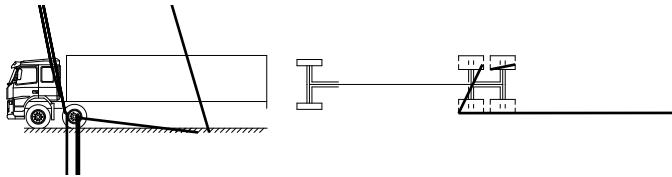
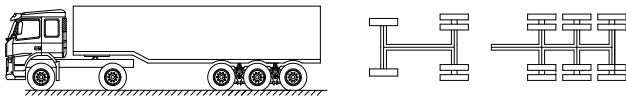
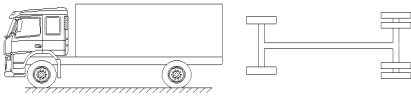



() 任务描述

-
-
-
-
-

() 任务描述

()

()

)	()		

()

()

()

()

()

○

()			

Sailing Schedule from : Shenzhen,Shenzhen,Guangdong,China

To : Los Angeles,Los Angeles,CA,United States

Origin City : Shenzhen,Shenzhen,Guangdong,China

Destination City : Los Angeles,Los Angeles,CA,United States

CY/DOOR

CY/DOOR

序列号	航线	船名	航次	截关时间	装货港	预计离港时间	实际离港时间	卸货港
1	YPSW	YM UNISON	59E	2016-04-22 17:00	Yantian	2016-04-25		Los Angeles
2	SEA	NORTHERN JAVELIN	002E	2016-04-23 12:00	Yantian	2016-04-27		Long Beach
3	AAS2	CMA CGM LIBRA	095TXE	2016-04-25 16:00	Yantian	2016-04-28		Long Beach
4	YPSW	YM UBIQUITY	22E	2016-04-29 17:00	Yantian	2016-05-02		Los Angeles
5	SEA	C SCL PUSAN	117E	2016-04-30 12:00	Yantian	2016-05-04		Long Beach
6	AAS2	CMA CGM COLUMBA	097TXE	2016-05-02 16:00	Yantian	2016-05-05		Long Beach
7	SEA	COSCO NINGBO	069W	2016-05-06 11:00	Yantian	2016-05-08		Long Beach
8	YPSW	YM JIREBY	50E	2016-05-06 17:00	Yantian	2016-05-09		Los Angeles
9	SEA	COSCO EXCELLENCE	027E	2016-05-07 12:00	Yantian	2016-05-11		Long Beach
10	AAS2	CMA CGM CENTAURUS	099TXE	2016-05-09 16:00	Yantian	2016-05-12		Long Beach
11	YPSW	YM MASCULINITY	32E	2016-05-13 17:00	Yantian	2016-05-16		Los Angeles



干货箱



	箱体内部尺寸			箱体内容积及载重量		箱门开度尺寸	
	L	W	H	Cu	P	W	H
20'	5898	2352	2393	33.2	21740/28230#	2340	2280
40'	12032	2352	2393	67.7	26630	2340	2280
HC	12032	2352	2698	76.3	26520	2340	2585

冷藏箱



	箱体内部尺寸			箱体内容积及载重量	
	L	W	H	Cu	P
20'	5444	2284	2267	28.5	21135/27160#
40'	11583	2284	2250	58.7	26580
HC	11583	2284	2659	67.9	26380

开顶箱

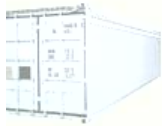

	箱体内部尺寸			箱体内容积及载重量	
	L	W	H	Cu	P
20'	5900	2330	2337	32.6	21740
40'	12025	2330	2337	65.8	26410

○

○

() 实施条件

() 考核时量

() 评分细则

1

() 任务描述



		<input type="checkbox"/>	<input type="checkbox"/>
		<input type="checkbox"/>	<input type="checkbox"/>

□		□		
□		□		



() 实施条件

() 考核时量

() 评分细则

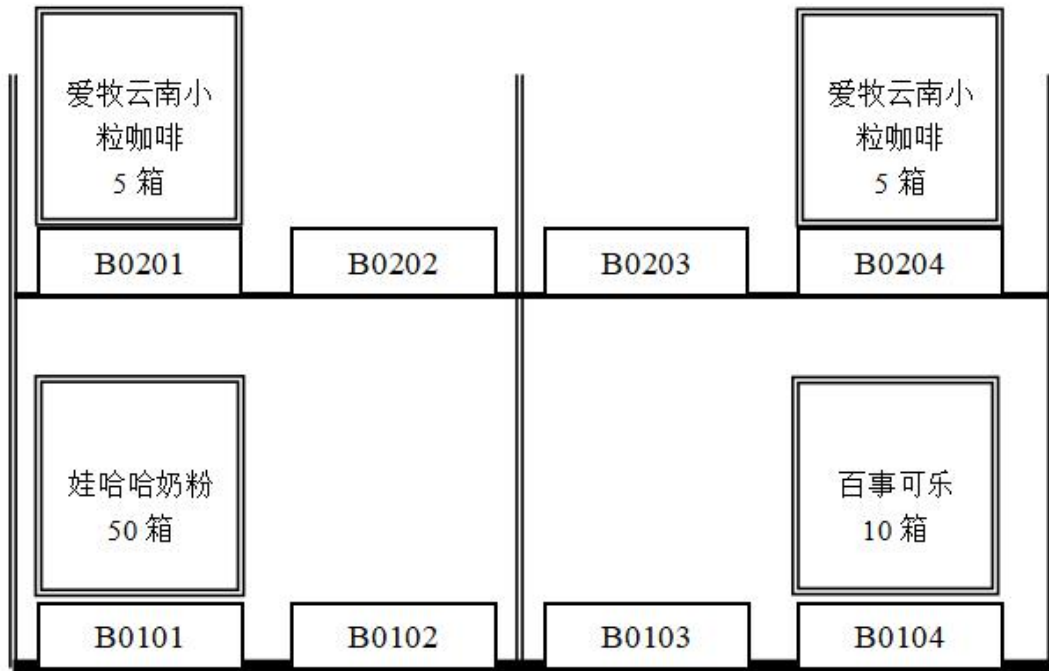

产品运输单

-
-
-
-
-
-
-
-

80				

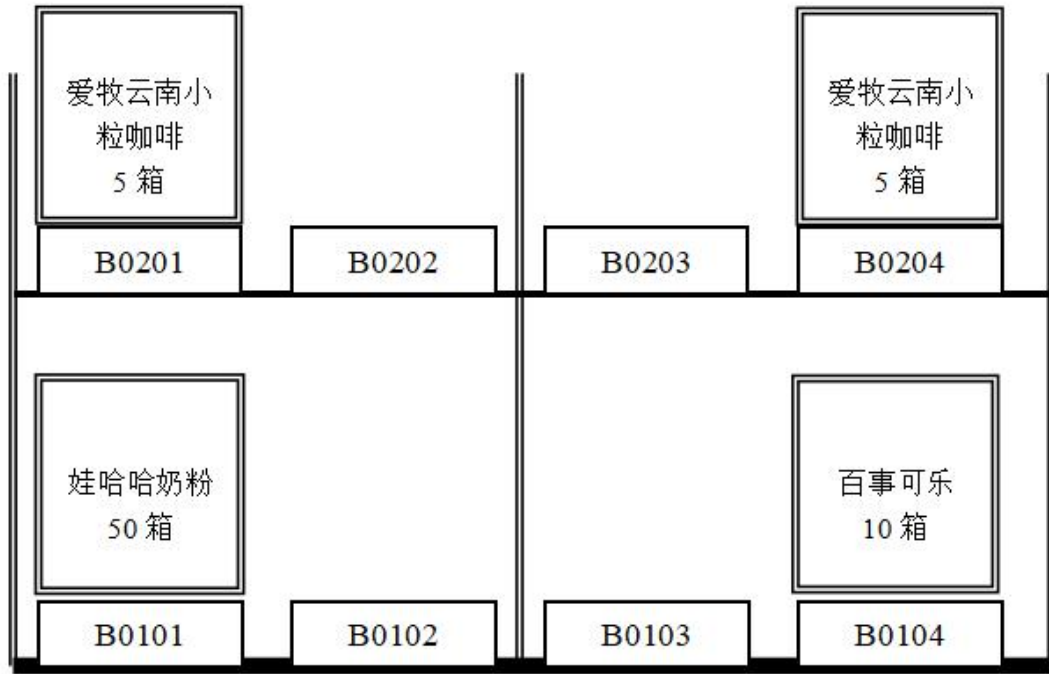

产品运输单

-
-
-
-
-
-
-
-

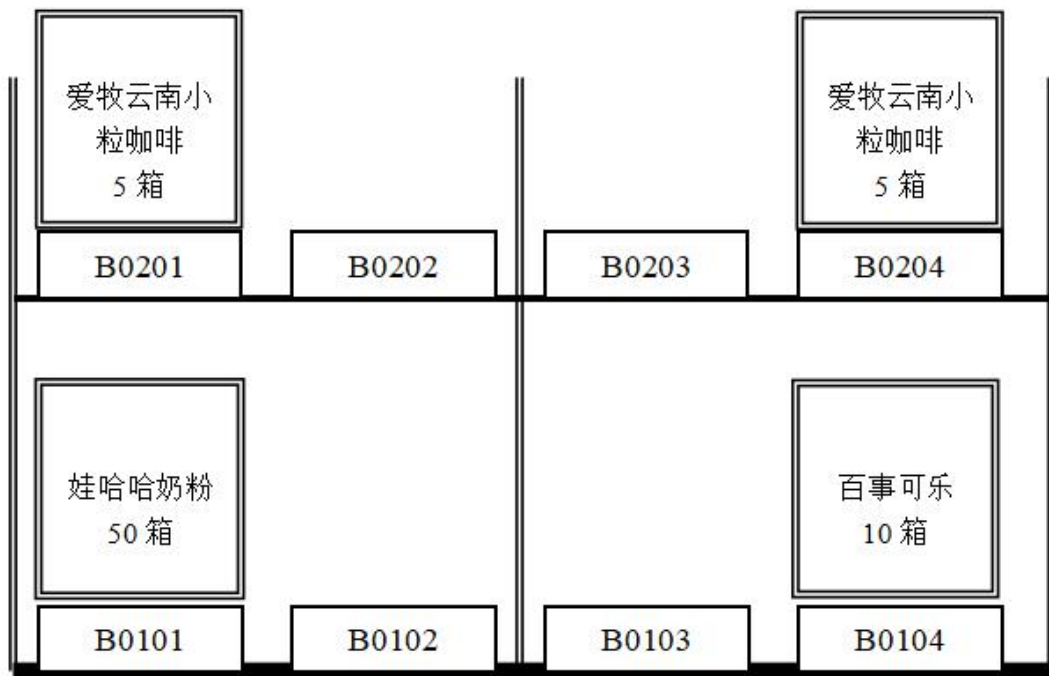

产品运输单

-
-
-
-
-
-
-
-



产品运输单

-
-
-
-
-
-
-
-



产品运输单

-
-
-
-
-

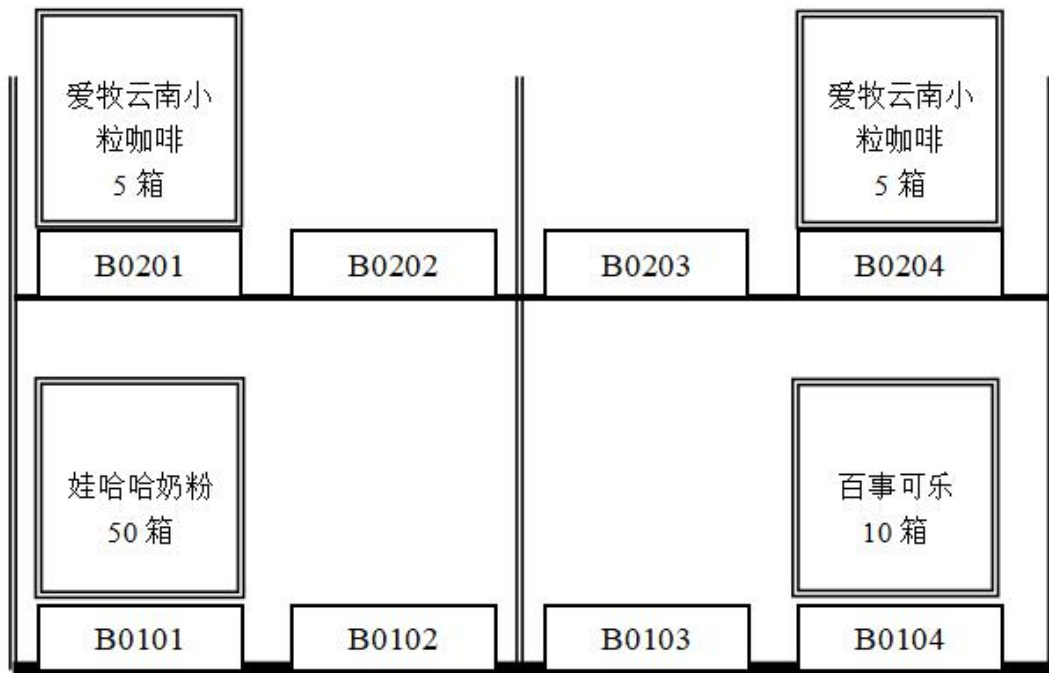

产品运输单

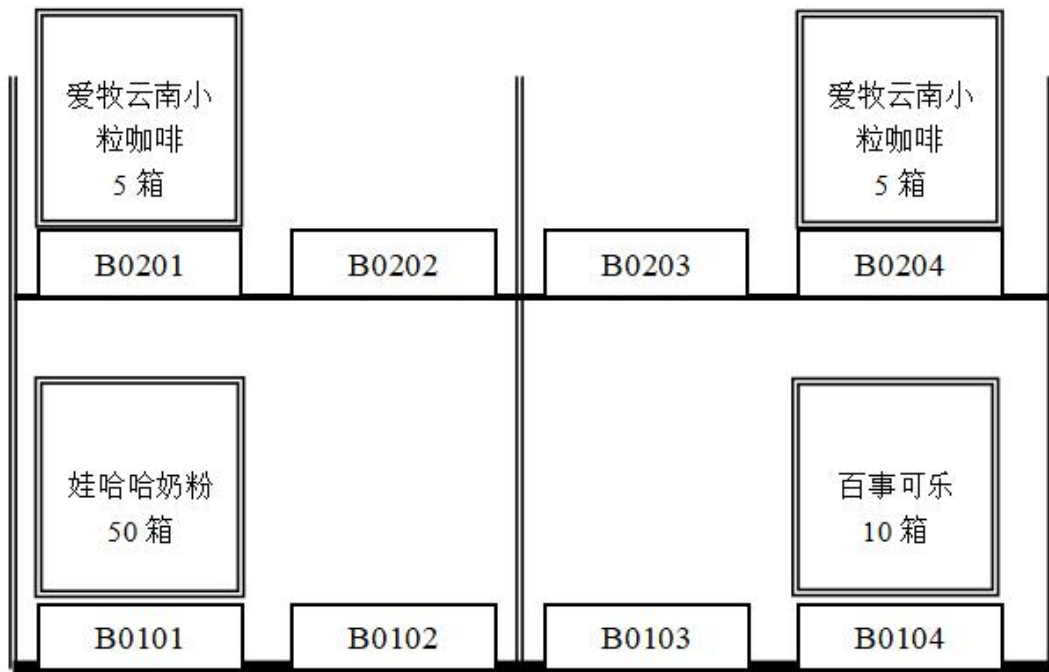

产品运输单

-
-
-
-
-
-
-
-
-



产品运输单

-
-
-
-
-
-
-
-
-



产品运输单

-
-
-
-
-
-
-
-
-

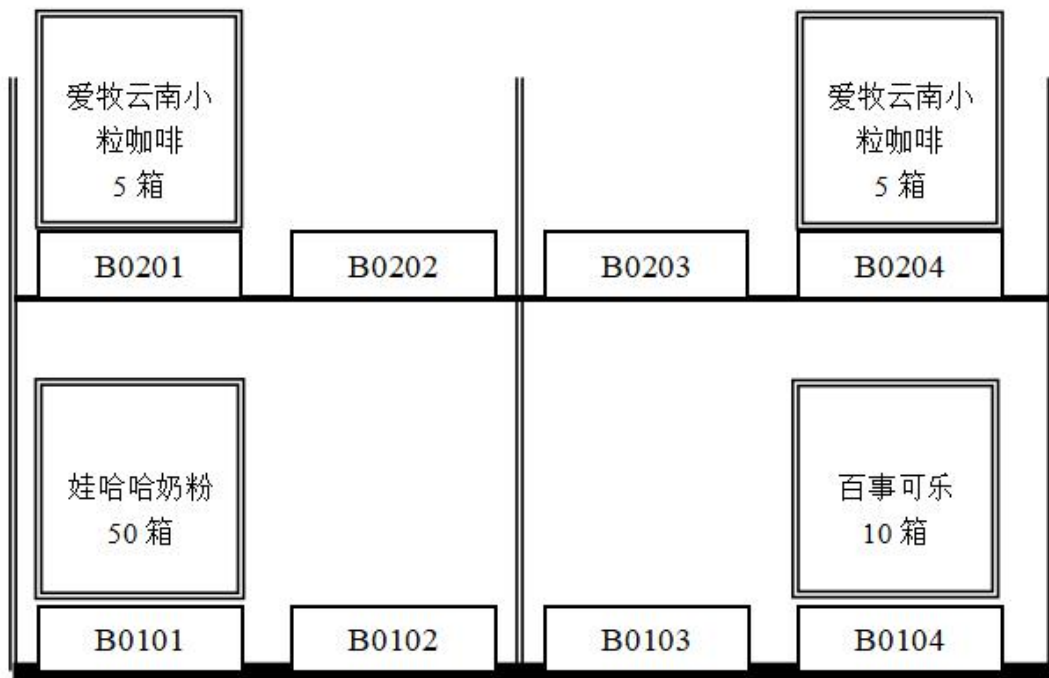

产品运输单

-
-
-
-
-
-
-
-

○

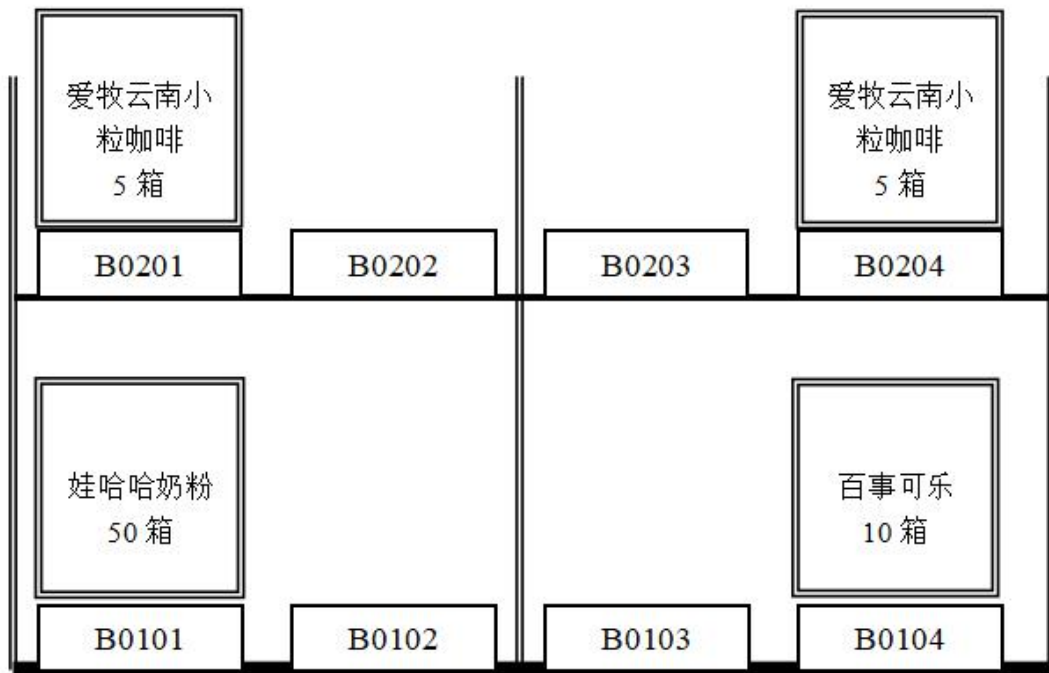



--	--	--	--	--	--

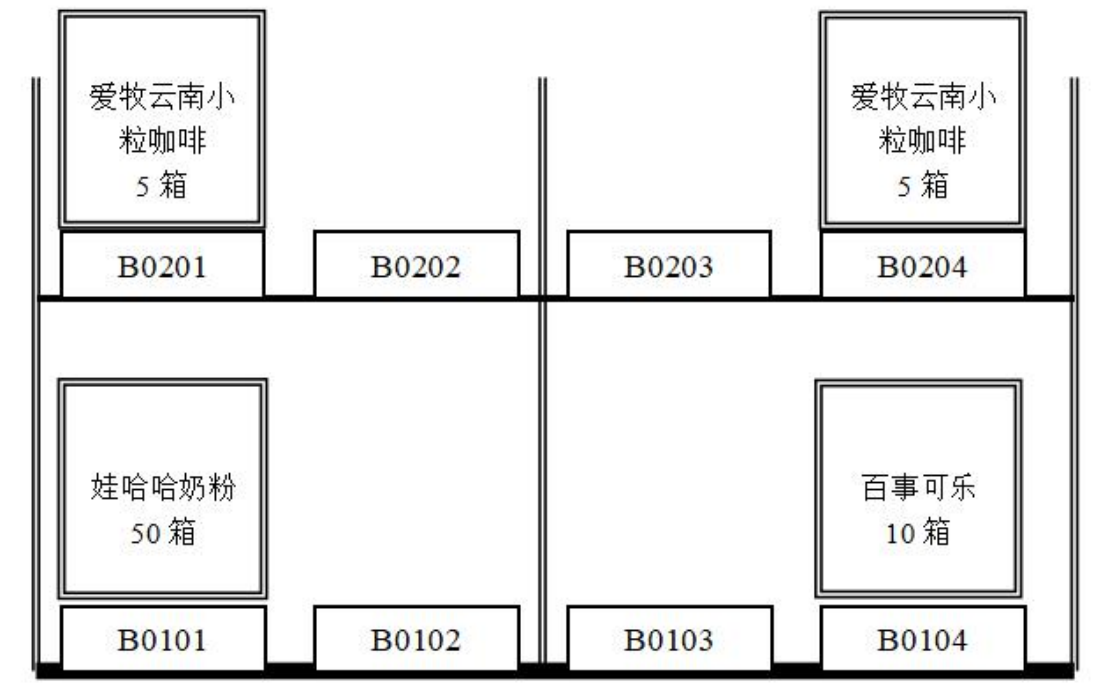

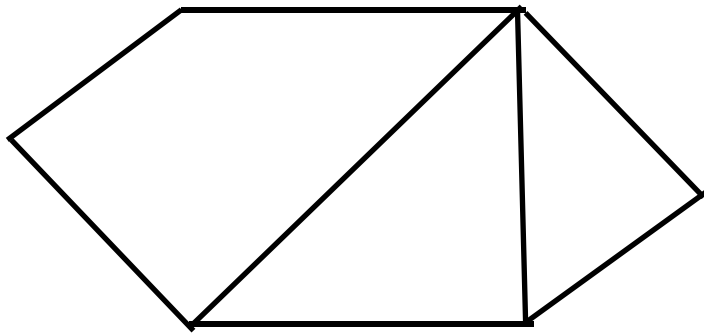

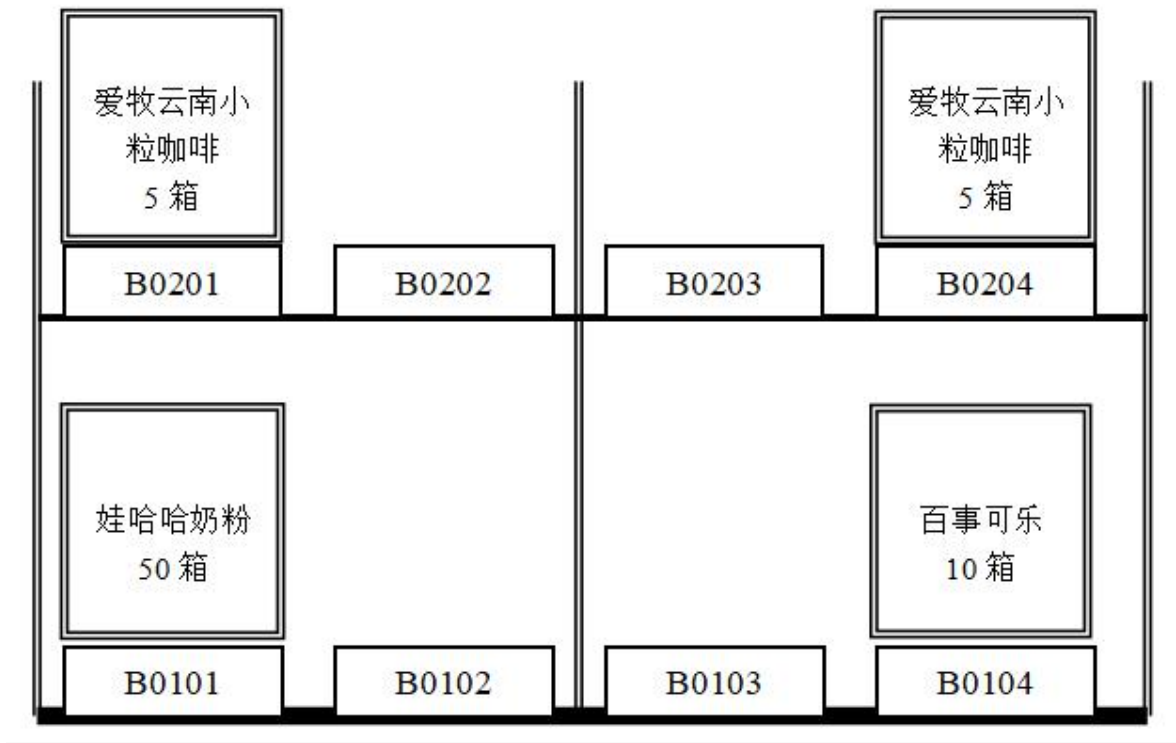
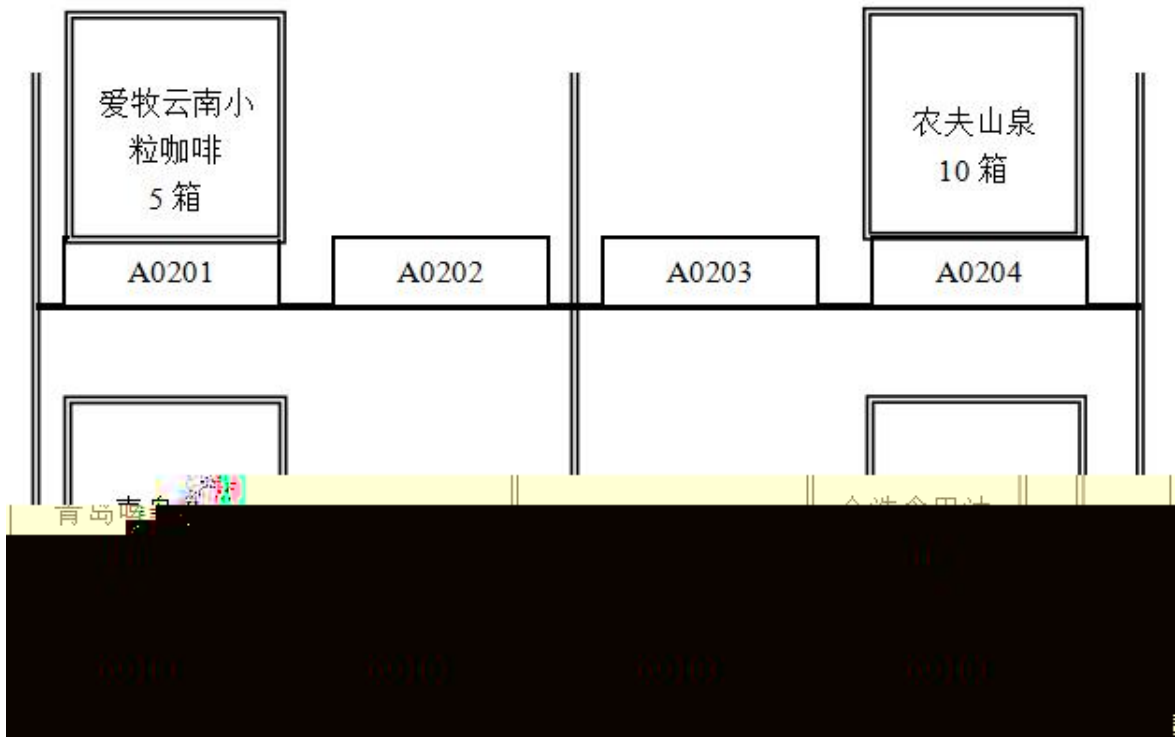

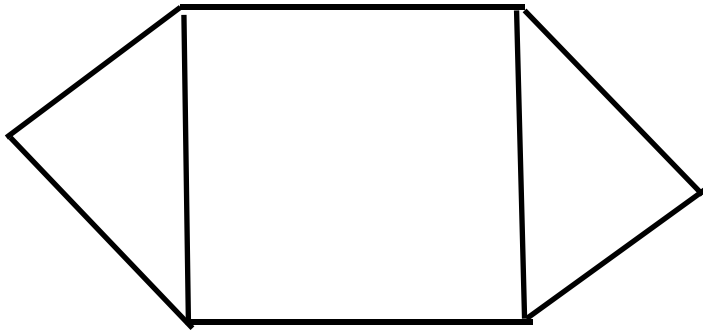

1

		---	---		

		---	---		

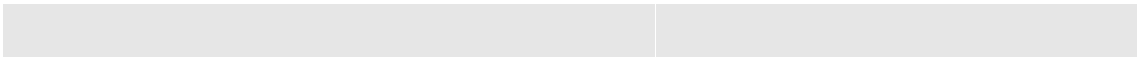

--- --

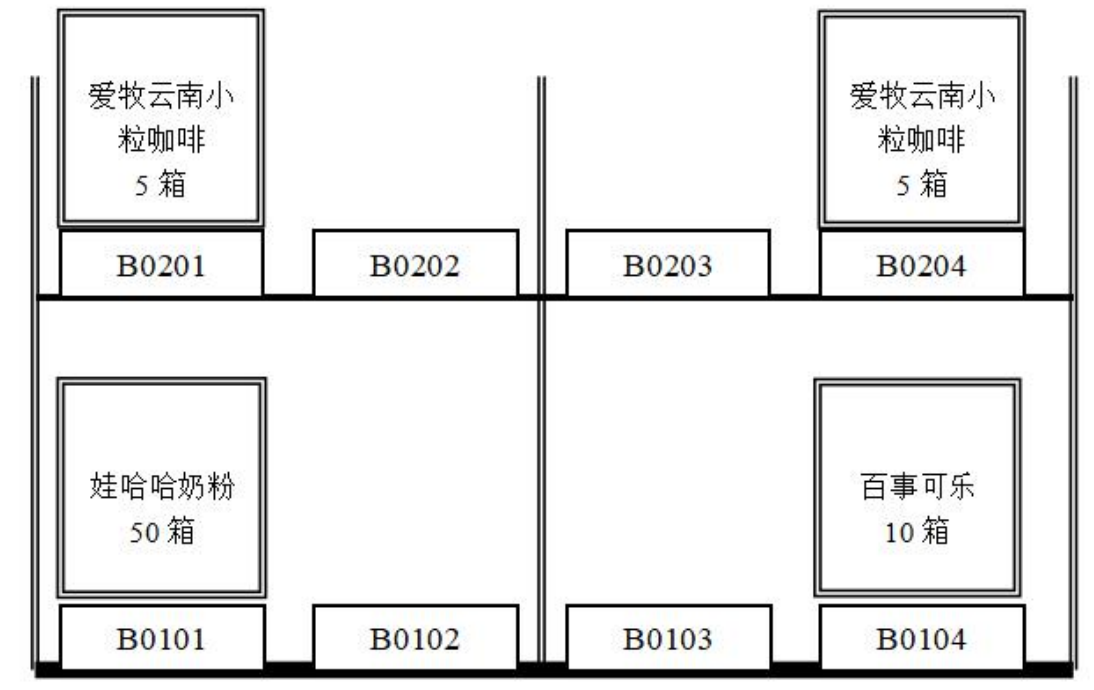

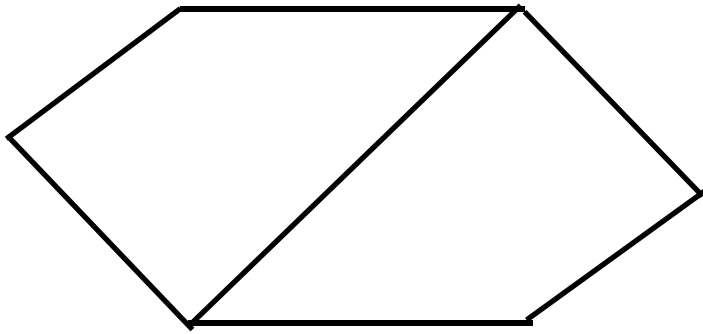

1

--	--	--	--	--	--

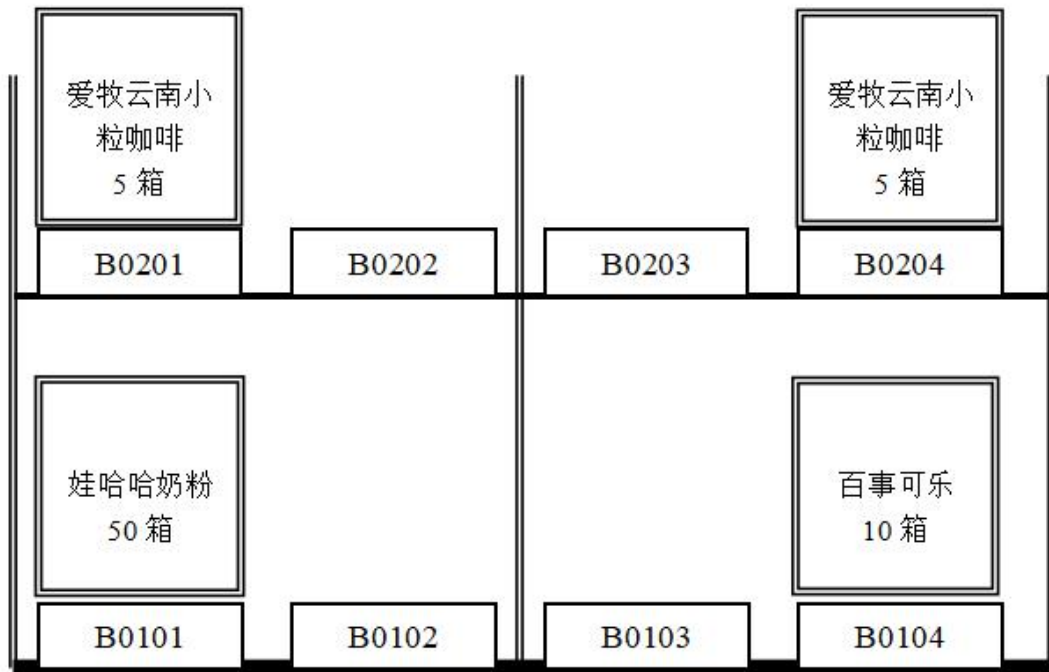

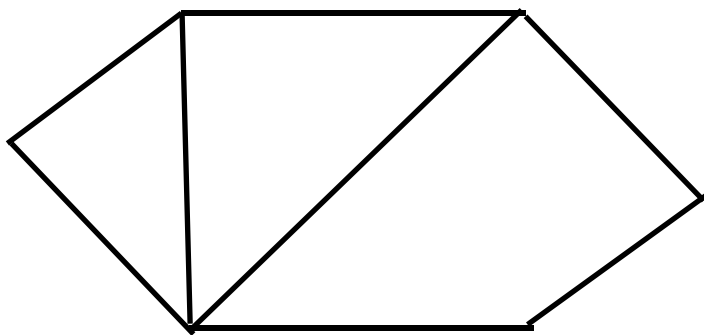

○

○

○

○

○

○

--

○

○

--	--

○

○

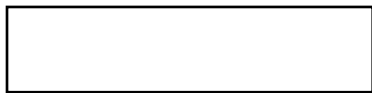

三、国际物流作业组织与管理模块

○

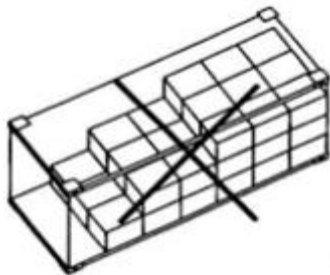
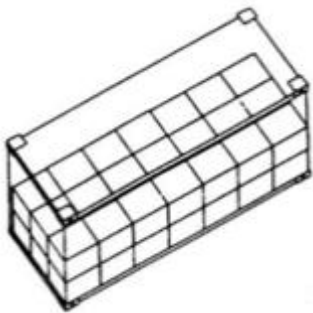

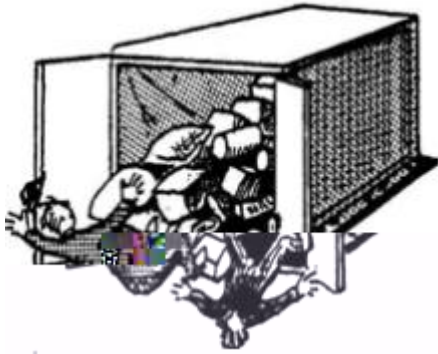
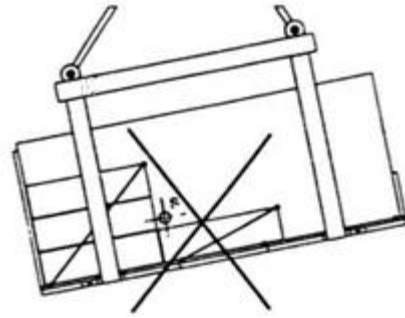

○

船公司	船名/航次	服务代码	航线	装船港/卸船港	启-达日期	天	挂港
Carrier	Ship/Voyage	Service	Lane	Load/Unload Port	ETD-ETA	Day	Port
MSC 地中海航运	MASTER 7408T		中国-香港台	HONG KONG 香港 HACHSUNG 香港	02/25 (二) 03/15 (六)	18	港 前
NYK 日本邮船	ITALIAN EXPRESS E 024		中国-香港台	HONG KONG 香港 BANGKOK 曼谷	02/25 (二) 03/02 (日)	8	港 前
CMA-CGM 法国航程	CMA CGM GEMINI JCA498		中国-欧洲	XIAMEN 厦门 DURBAN 德班	02/25 (二) 03/27 (四)	30	港 前
KLINE 地中海	BYUNDAI PLATINUM M 004T		中国-中澳美	SHANGHAI 上海 PAPANAGUA 巴哈利亚	02/25 (二) 04/09 (三)	43	港 前
EMS 达飞轮船	COSSO KACHSIUN S/0F846E		中国-澳洲	HONG KONG 香港 NOUMEA 努美阿	02/25 (二) 04/02 (三)	36	港 前
PCL 长海轮运	ROTA PERMASAN VPM114		中国-中东/波斯湾/印度	QINGDAO 青岛 MADRAS 马德拉斯	02/26 (三) 03/16 (二)	18	港 前
ZIM 以星轮船	KUD HUNG 311	CHINA_VIETNAM AM OYK	中国-香港台	NINGBO 宁波 HONG KONG 香港	02/25 (二) 03/15 (六)	18	港 前
SAFARI 比利时报航	HEIRE P 1404		中国-欧洲	HACHSUNG 香港 MONTELO	02/25 (二) 04/05 (十)	39	港 前
SEAN 长荣海运	SAN NICOLA S 01409		中国-中澳美	SHANGHAI 上海 RIO GRANDE 里奥格兰德	02/25 (二) 04/07 (一)	41	港 前
OOCL 东方海外	OPREDEN EXPRESS S 18808	Pacific Atlantic PAX	中国-澳洲	SHANGHAI 上海 HALIFAX 哈利法克斯	02/25 (二) 04/14 (一)	48	港 前

○
○

BEIJING	CN		BJ\$
Y. RENMINBI	CNY		KGS
BOSTON	1000000	1000000	1000000
		1000000	1000000
		1000000	1000000
		1000000	1000000
		1000000	1000000
		1000000	1000000

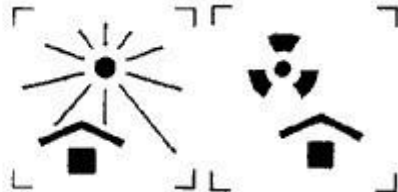
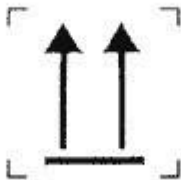
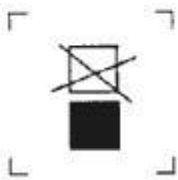

○

○

○

集装箱设备交接单
EQUIPMENT INTERCHANGE RECEIPT

OUT 出场

用箱人/运箱人(CNTR. USER/HAULIER)			提箱地点(PLACE OF DELIVERY)		
发往地点(DELIVERED TO)			返回/收箱地点(PLACE OF RETURN)		
船名/航次(VESSEL/VOYAGE No.)		集装箱号(CNTR. No.)		尺寸/类型(SIZE/TYPE)	
船东/代理(SHIP/AGENCY)		承运人(CNTR. OPTR)		提箱日期(TIME-OUT)	
箱号(Seal No.)		箱封号(SEAL No.)		免费期限(FREE TIME PERIOD)	
货物(CARGO W.)		出场目的/状态(PPS OF GATE-OUT/STATUS)		进场目的/状态(PPS OF GATE-IN/STATUS)	
				出场日期(TIME-OUT) 月 日 时	
出场检查记录(INSPECTION AT THE TIME OF INTERCHANGE)					
普通集装箱(GP. CNTR.)		冷藏集装箱(RC. CNTR.)		特种集装箱(SEL. CNTR.)	
<input type="checkbox"/> 正常(SOUND) <input type="checkbox"/> 异常(DEFFECTIVE)		<input type="checkbox"/> 正常(SOUND) 设定温度(SET) <input type="checkbox"/> 异常(DEFFECTIVE) 记录温度(RECORDED)		<input type="checkbox"/> 正常(SOUND) <input type="checkbox"/> 异常(DEFFECTIVE)	
损坏记录及代号(DAMAGE CODE)				发电机(GEN. SET)	
				<input type="checkbox"/> 正常(SOUND) <input type="checkbox"/> 异常(DEFFECTIVE)	
B (BROKEN) D (DENT) M (MISSING) DR (DIRTY) DL (DGLABEL)					
左侧 (LEFT SIDE)		右侧 (RIGHT SIDE)		内部 (INSIDE)	
顶部 (TOP)		底部 (FLOOR BASE)		前部 (FRONT)	
				后部 (REAR)	
如有异状, 请注明程度及尺寸 (REMARK)					
除列明者外, 集装箱设备交接时完好无损, 箱封完整无误。 TERCHANGED IN SOUND CONDITION AND SEAL INTACT UNLESS OTHERWISE STATED			CONTAINER EQUIPMENT IN		
码头/堆场供箱员签署 (TERMINAL/DEPOT CLERK'S SIGNATURE)			用箱人/运箱人签署 (CONTAINER USER/HAULIER'S SIGNATURE)		
年 月 日			年 月 日		
GB/T 16661-1996 格式印制					



--	--	--	--	--	--

--	--	--

--	--	--	--	--	--

--	--	--	--	--	--

--	--	--	--	--	--	--	--

○

WILKINS

○	■ ■

[]

○

--	--	--

--	--	--	--	--	--

○

○

○

○

四、 快递物流作业组织与管理模块

--	--	--	--	--	--



出示身份证件实名信息录入, 确保信息安全

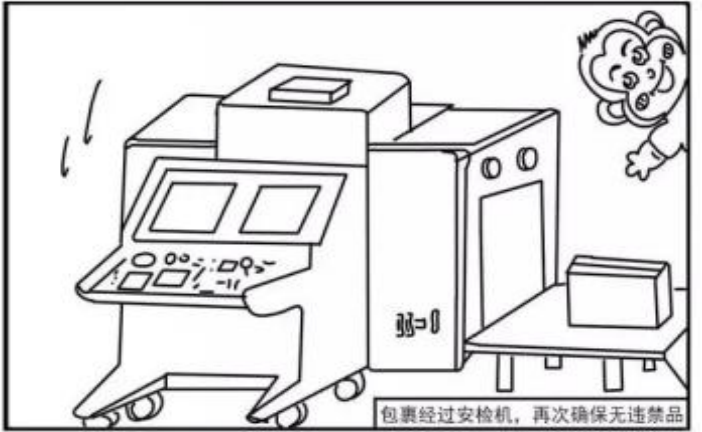

包裹经过安检机, 再次确保无违禁品



宅急送, 致力于成为中国最有价值的综合物流服务商

--	--	--	--	--	--

--	--	--	--	--	--

[想知道:中国成都理工大学校园快递具体在哪? 百度知道](#)

3个回答 - 提问时间: 2014年02月10日

最佳答案  均在银杏后面。宝盒、圆通、顺丰在电影院后面。中通、申通在图书馆下面。常用的是这几个。

zhidao.baidu.com/link?... 2014-02-15 - 百度快照 - 80%好评

--	--	--	--

--	--	--	--

<hr/>
